

Rules of Procedure for the Town of Chester Planning Commission

A. PURPOSE.

The Planning Commission of Chester, is required by law to conduct its meetings in accordance with the Vermont Open Meeting Law. 1 V.S.A. §§ 310-314. Meetings of the Chester Planning Commission must be open to the public at all times, except as provided in 1 V.S.A. § 313.

B. APPLICATION.

This policy setting forth rules of procedure shall apply to the Chester Planning Commission, which is referred to below as “the body.” These rules shall apply to all regular, special, and emergency meetings of the body.

C. ORGANIZATION.

1. The body shall annually elect a chair and a vice-chair. The chair of the body or, in the chair’s absence, the vice-chair shall preside over all meetings. If both the chair and the vice-chair are absent, a member selected by the body shall act as chair for that meeting.
2. The chair shall preserve order in the meeting and shall regulate its proceedings by applying these rules and making determinations about all questions of order or procedure.
3. A majority of the members of the body shall constitute a quorum. If a quorum of the members of the body is not present at a meeting, no meeting shall take place.
4. No single member of the body shall have authority to represent or act on behalf of the body unless, by majority vote, the body has delegated such authority for a specific matter at a duly-noticed meeting and such delegation is recorded in the meeting minutes.
5. Motions made by members of the body require a second. The chair of the body may make motions and may vote on all questions before the body. A motion will only pass if it receives the votes of a majority of the total membership of the body.
6. There is no limit to the number of times a member of the body may speak to a question. A member may speak or make a motion without being recognized by the chair. Motions to close or limit debate will not be entertained.
7. Any member of the body may request a roll call vote. Pursuant to 1 V.S.A. § 312(a)(2), when one or more members attend a meeting electronically, a roll call vote is required for votes that are not unanimous.
8. Meetings may be recessed to a time and place certain.
9. These rules may be amended by a super majority (meaning 4 of 5 Commission members) vote of the body, and must be readopted annually.
10. The chair may be removed at any time by a super majority vote of the seated commissioners.

D. AGENDAS.

1. Each regular and special meeting of the body shall have an agenda,. Those who wish to be added to the meeting agenda shall contact the chair to request inclusion on the agenda. The chair shall determine the final content of the agenda.
2. At least 48 hours prior to a regular meeting, and at least 24 hours prior to a special meeting, a meeting agenda shall be posted on the interior and exterior bulletin boards at the town hall and on the town website, chestervt.gov. The agenda must also be made available to any person who requests such agenda prior to the meeting.
3. All business shall be conducted as it appears on the noticed agenda, except that any deletion from the noticed agenda must be made as the first act of business at the meeting. No deletions from the agenda shall be considered once the first act of business at the meeting has commenced. Any other adjustment to the noticed agenda, for example, changing the order of business, postponing or tabling actions, may be made by a majority vote of the body.

E. MEETINGS.

1. Regular meetings shall take place on the first and third Mondays of the month at 6:30, at the Chester Town Hall and/or electronically.
2. Special meetings shall be publicly announced at least 24 hours in advance by giving notice to all members of the body unless previously waived; to an editor, publisher or news director, or radio station serving the area; and to any person who has requested notice of such meetings. In addition, notices shall be posted on the interior and exterior bulletin boards at the town hall and on the town website, chestervt.gov.
3. Emergency meetings may be held without public announcement, without posting of notices, and without 24-hour notice to members, provided some public notice thereof is given as soon as possible before any such meeting. Emergency meetings may be held only when necessary to respond to an unforeseen occurrence or condition requiring immediate attention by the body.
4. A member of the body may attend a regular, special, or emergency meeting by electronic or other means without being physically present at a designated meeting location, so long as the member identifies him or herself when the meeting is convened, and is able to hear and be heard throughout the meeting. Whenever one or more members attend electronically, voting that is not unanimous must be done by roll call. If a quorum or more of the body attend a meeting (regular, special, or emergency) without being physically present at a designated meeting location, the agenda for the meeting shall designate at least one physical location where a member of the public can attend and participate in the meeting. At least one member of the body, or at least one staff or designee of the body, shall be physically present at each designated meeting location.

F. PUBLIC PARTICIPATION.

1. All meetings of the body are meetings in the public, not of the public. Members of the public shall be afforded reasonable opportunity to express opinions about matters considered by the body, so long as order is maintained according to these rules.
2. At the end of each agenda item, but before any action is taken by the body at each meeting. The chair may limit the time allotted for public comment. By a majority vote, the body may increase the time for open public comment and its place on the agenda.
3. Comment by the public or members of the body must be addressed to the chair or to the body as a whole, and not to any individual member of the body or public.
4. Members of the public must be acknowledged by the chair before speaking.
5. If a member of the public has already spoken on a topic, he or she may not be recognized again until others have first been given the opportunity to comment.
6. Order and decorum shall be observed by all persons present at the meeting. Neither members of the body, nor the members of the public, shall delay or interrupt the proceedings or the peace of the meeting or interrupt or disturb any member while speaking. Members of the body and members of the public are prohibited from making personal, impertinent, threatening, or profane remarks.
7. Members of the body and members of the public shall obey the orders of the chair or other presiding member. The chair should adhere to the following process to restore order and decorum of a meeting, but may bypass any or all steps when he or she determines in his or her sole discretion that deviation from the process is warranted:
 - a. Call the meeting to order and remind the members of the applicable rules of procedure.
 - b. Declare a recess or table the issue.
 - c. Adjourn the meeting until a time and date certain.
 - d. Order the constable to remove disorderly person(s) from the meeting.

ADOPTED: May 3rd 2023

_____ Hugh Quinn, Chair

_____ Tim Roper Vice Chair

_____ John Cummings

_____ Catherine Hasbrouck

_____ Barre Pinske

Conflict of Interest Policy

TOWN OF CHESTER

Article 1. Authority. Under the authority granted in 24 V.S.A. § 2291(20), the Town of Chester hereby adopts the following policy concerning conflicts of interest.

Article 2. Purpose. The purpose of this policy is to ensure that the business of the Town will be conducted in such a way that no public officer of the Town will gain a personal or financial advantage from his or her work for the Town and so that the public trust in Town officials will be preserved. It is also the intent of this policy to ensure that all decisions made by Town officials are based on the best interest of the community at large.

Article 3. Application. This policy applies to all public officers as that term is defined below.

Article 4. Definitions. For the purposes of this policy, the following definitions shall apply:

A. **Conflict of interest** means any of the following:

1. A direct or indirect personal or financial interest of a public officer, his or her spouse, household member, child, stepchild, parent, grandparent, grandchild, sibling, aunt or uncle, brother- or sister-in-law, business associate, or employer or employee in the outcome of a cause, proceeding, application, or any other matter pending before the officer or before the public body in which he or she holds office or is employed.
2. A situation where a public officer has publicly displayed a prejudgment of the merits of a particular quasi-judicial proceeding that inhibits impartial judgment by the public officer. This shall not apply to a member's particular political views or general opinion on a given issue.
3. A situation where a public officer has not disclosed ex parte communications with a party in a quasi-judicial proceeding.

A "conflict of interest" does not arise in the case of votes or decisions on matters in which the public officer has a personal or financial interest in the outcome, such as in the establishment of a tax rate that is no greater than that of other persons generally affected by the decision.

B. **Emergency** means an imminent threat or peril to the public health, safety, or welfare.

C. **Ex Parte Communication** means direct or indirect communication between a member of a public body and any party, party's representative, party's counsel or any person interested in the outcome of a quasi-judicial proceeding, that occurs outside the proceeding and concerns the substance or merits of the proceeding.

D. **Official act or action** means any legislative, administrative, or quasi-judicial act performed by any public officer while acting on behalf of the Town.

E. **Public body** means any board, council, commission, or committee of the Town.

F. **Public interest** means an interest of the community as a whole, conferred generally upon all residents of the Town.

Conflict of Interest Policy

TOWN OF CHESTER

- G. **Public officer** means a person elected or statutorily-appointed to perform executive, administrative, legislative, or quasi-judicial functions for the Town. This term does not include any municipal employee.
- H. **Quasi-judicial proceeding** means a case in which the legal rights of one or more persons who are granted party status are adjudicated, which is conducted in such a way that all parties have opportunities to present evidence and to cross-examine witnesses presented by other parties, and which results in a written decision, the result of which is appealable by a party to a higher authority.

Article 5. Prohibited Conduct.

- A. A public officer shall not participate in any official action if he or she has a conflict of interest in the matter under consideration.
- B. A Selectboard member shall be prohibited from serving as a member on either the Planning Commission or Development Review Board. This prohibition does not include Selectboard membership on any committee or subcommittee of the foregoing public bodies.
- C. A public officer shall be prohibited from serving as a member simultaneously on the Planning Commission and Development Review Board. However, if after reasonable efforts the Selectboard is unable to fill vacancies on either the Planning Commission or Development Review Board that exist for more than 3 months the Selectboard may appoint a member of the Planning Commissioner to serve as a member to the Development Review Board and vice versa.
1. Nothing in Article 5C shall prohibit a Planning Commission member from serving as a member on any committee or subcommittee of the Development Review Board and vice versa.
- D. A public officer shall not personally – or through any member of his or her household, business associate, employer or employee – represent, appear for, or negotiate in a private capacity on behalf of any person or organization in a cause, proceeding, application, or other matter pending before the public body in which the public officer holds office.
- E. A public officer shall not accept gifts or other offerings for personal gain by virtue of his or her public office that are not available to the public in general.
- F. A public officer shall not use resources unavailable to the general public – including but not limited to municipal staff time, equipment, supplies, or facilities – for private gain or personal purposes.

Article 6. Disclosure. A public officer who has reason to believe that he or she has or may have a conflict of interest in a particular matter shall, prior to participating in any official action on the matter, publicly disclose at a public meeting or public hearing that he or she has an actual or perceived conflict of interest in the matter under consideration and disclose the nature of the actual or perceived conflict of interest. Alternatively, a public officer may request that another public officer recuse him or herself from a matter due to a conflict of interest.¹

¹ Such request shall not be considered an order for the officer to recuse him or herself.

Conflict of Interest Policy

TOWN OF CHESTER

Article 7. Consideration of Recusal. Once there has been a disclosure of an actual or perceived conflict of interest, other public officers may be afforded an opportunity to ask questions or make comments about the situation. If a previously unknown conflict is discovered during a meeting or hearing conducted by a public body of the Town, the public body may take evidence pertaining to the conflict and, if appropriate, adjourn to an executive session to address the conflict.

Article 8. Recusal.

- A. **Recusal of Elected Officers.** After taking the actions listed in Articles 6 and 7, an elected public officer should declare whether he or she will recuse him or herself and explain the basis for that decision. If the public officer has an actual or perceived conflict of interest but believes that he or she is able to act fairly, objectively, and in the public interest, in spite of the conflict, he or she shall state why he or she believes that he or she is able to act in the matter fairly, objectively, and in the public interest.²
- B. **Recusal of Appointed Officers.** The failure of an appointed public officer to recuse himself or herself in spite of a conflict of interest may be grounds for discipline or removal from office.³

Article 9. Post-Recusal Procedure.

- A. A public officer who has recused himself or herself from serving on a public body in a particular proceeding shall not sit with the public body, deliberate with the public body, or participate in that proceeding as a member of the public body in any capacity, though such member may still participate as a member of the public.
- B. The public body may adjourn the proceedings to a time certain if, after a recusal, it may not be possible to take action through the concurrence of a majority of the total membership of the public body. The public body may then resume the proceeding with sufficient members present.

Article 10. Enforcement.

- A. **Enforcement Against Elected Officers; Progressive Consequences for Failure to Follow the Conflict of Interest Procedures.** In cases where an elected public officer has engaged in any of the prohibited conduct listed in Article 5, or has not followed the conflict of interest procedures in Articles 6 through 9, the Chester Selectboard may take progressive action to discipline such elected officer as follows:

² Each member of an elected public body is independently elected and answers only to the voters. Therefore, unless there is a local ordinance or charter provision that states otherwise, the remaining members of the body may not force recusal. They may only express their opinion about the subject and/or privately or publicly admonish a fellow member who fails to handle conflicts appropriately.

³ Certain appointed officials such as a Zoning Administrator and a Town Manager may only be removed for cause and after being afforded with procedural due process protections including notice and a reasonable opportunity to be heard.

Conflict of Interest Policy

TOWN OF CHESTER

1. The chair of the Chester Selectboard may meet informally with the public officer to discuss the possible conflict of interest violation. This shall not take place in situations where the chair and the public officer together constitute a quorum of a public body.
2. The Chester Selectboard may meet to discuss the conduct of the public officer. Executive session may be used for such discussion in accordance with 1 V.S.A. § 313(a)(4). The public officer may request that this meeting occur in public. If appropriate, the Chester Selectboard may admonish the offending public officer in private.
3. If the Chester Selectboard decides that further action is warranted, the Chester Selectboard may admonish the offending public officer at an open meeting and reflect this action in the minutes of the meeting. The public officer shall be given the opportunity to respond to the admonishment.
4. Upon majority vote in an open meeting, the Chester Selectboard may request (but not order) that the offending public officer resign from his or her office.

B. Enforcement Against Appointed Officers. The Chester Selectboard may choose to follow any of the steps articulated in Article 10A. In addition to or in lieu of any of those steps, the Chester Selectboard may choose to remove an appointed officer from office, subject to state law.

Article 11. Exception. The recusal provisions of Article 8 shall not apply if the Chester Selectboard determines that an emergency exists and that actions of the public body otherwise could not take place. In such a case, a public officer who has reason to believe he or she has a conflict of interest shall disclose such conflict as provided in Article 6.

Article 12. Effective Date. This policy shall become effective immediately upon its adoption by the Chester Selectboard.

Signatures:

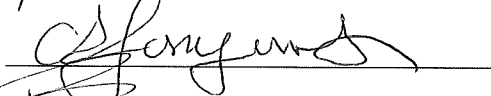
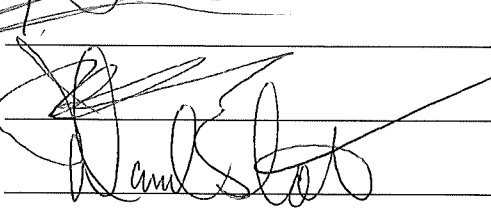
Date:

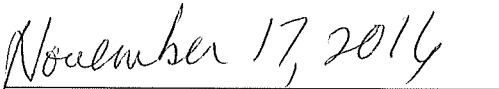

1
2
3
4
5
6
7
8
9
10
11
12
13
14
15
16
17
18
19
20
21
22
23
24
25
26
27
28
29
30
31
32
33
34
35
36
37
38
39
40
41
42
43
44
45

TOWN OF CHESTER
PLANNING COMMISSION
March 18, 2024, Minutes

Commission Members Present: Cathy Hasbrouck, Barre Pinske, and Hugh Quinn at Town Hall.

Staff Present: Preston Bristow, Zoning Administrator/Town Planner, at Town Hall; and Susan Bailey, Recording Secretary, via Zoom.

Citizens Present: Jason Rasmussen, Executive Director of MARC, Peter Hudkins, and Bill Lindsay at Town Hall; and Arne Jonynas and Tim Roper (Arne left the meeting when Tim joined at 6:51) via Zoom.

Call to Order

Chair Hugh Quinn called the meeting to order at 6:36 p.m.

Agenda Item 1, Review and Approve Minutes from February 26, 2024, meeting

Cathy moved and Barre seconded a motion to approve the minutes. There were no changes. The minutes were approved unanimously, as written.

Agenda Item 2, Citizens Comments

There were no comments.

Agenda Item 3, Continue discussion on Rural district map and UDB updates.

Jason said the maps had not been changed since the last time and had made changes to the matrix or table and narrative for the zoning districts. They had gotten through Residential 2-acre District and the Rural Mixed-Use District. Jason had some questions and said there were some errors and omissions when he went through the table and hoped they were consistent.

For the Residential 2 District, they had added art studio and/or gallery as an allowed use. They had added tiny house community and Jason had questions about what they wanted the language to be and asked if there were any questions or concerns about the allowed uses in the Residential 2 District. Hugh knew they discussed the need to create a definition or placeholder for a tiny house community and Jason had done that, so they had something that could be the beginning of a definition for that, and Jason agreed. Hugh said they agreed they were going to break extracting and processing of stone into two different categories which they had done. They are calling for extraction operations to be a conditional use in this district. Jason said in the Residential 2 District, he wanted the two terms to be together in the definition and called it earth extraction operations and earth processing operations. In the earth extraction definition, he had struck out the last part that dealt with processing and added a new definition with much of the same language. Jason had not included earth processing operations in the Residential 2 District, but it was up for discussion.

1 Peter suggested they consider it in terms of noise. An earth processing gravel pit was not like a
2 quarry and wasn't a noise operation. If earth extraction doesn't allow for crushing, they've wiped
3 out that option. Nobody will dig gravel out to run it somewhere else to be crushed. Earth processing
4 would need to be able to crush. Noisy things are drilling and rock hammer. Peter suggested
5 thinking about processing as making a dimensional material because you would saw and hammer
6 and have a lot of hand work. Cathy said there would be two uses and if they put crushing or
7 processing in as a companion use in the description of the zone, someone could apply for both
8 uses. Peter said they were in the 2-acre zone and that's where the town's gravel pit is so they would
9 have to take it out and take it someplace else. Cathy disagreed and said they could allow Res-2 to
10 have both extraction and processing, they could apply for a permit that has both. Peter asked if
11 they would have processing in Res-2 and didn't think they would want the same sawing that was
12 happening on Chandler Road. Hugh agreed and clarified that Peter was saying in extraction
13 operations, they should have latitude for a crusher or whatever needed to break the stone down
14 when it's pulled off the base or dug. Peter said what the town would remove could be dug with an
15 excavator. Barre explained it was gravel and not quarrying and Peter agreed. Hugh asked if gravel
16 extraction was different from quarrying and Peter agreed. Peter said bank run gravel is the coarse
17 gravel like in a quarry and what is dug out of the river and different from hard-faced. Cathy said
18 in the research she had done related to Julian; quarrying applies to gravel as much as solid stone
19 off a face and there didn't seem to be any distinction. Peter said a distinction could easily be made
20 because it could be called for a sieve. Anything that would fit through a 24" sieve could be crushed.
21 Peter suggested saying if it's dug up and fits through a 24" sieve, they would be all set. Nothing
22 of Julian's would fit through a 24" sieve. Hugh said in Residential 2, hammering, drilling the stone
23 off the face, and processing it into finished goods was probably something they don't want in Res
24 2 going forward so they needed to figure out how to allow gravel extraction such as through a
25 sieve because digging it up and crushing it wouldn't be as noisy as hammering, sawing, and
26 blasting and whatever else was required. They needed to figure out how to separate those two
27 operations so extraction and crushing would be allowed in Res 2 but not quarrying or the other
28 stuff that is noisy.

29
30 Barre thought the reason they were considering it was because of land the town had and if it was
31 allowed under conditional use review, it could be disallowed in all the other places. Hugh thought
32 that was tricky. Peter said where the town lot was, there had been crushers there for years. Barre
33 wondered if there was any other land in the purple that would have gravel and didn't think there
34 was any stone there that someone would want to quarry, so it was a non-issue. Barre agreed
35 somewhat with Peter and thought it would be nice to consider the town gravel theirs and it would
36 be more convenient to scoop up and run through a crusher. Barre added that Palmer has all kinds
37 of stuff brought to him as others do, where they crush on the spot because of noise and didn't think
38 they needed to include crushing in the purple zone unless they wanted to save the money like what
39 Peter was saying and it would be good for the community. Peter said because crushers are so
40 expensive, a lot of people will have a portable crusher brought to them. Barre said part of the
41 problem in the past was they didn't want the noise because of kids in school and Peter said it was
42 because of the drill. But Barre said they had talked about the crushers in letters-to-the-editor. Barre
43 thought because the town had the land, they were jumping through hoops to make it work but when
44 it was private, they wanted to shut them down. Peter said the problem was there was an active Act
45 250 permit that controls the decibel level at the high school to 36 decibels. Preston said they had
46 extraction operations criteria in 3.9 which reinforced the idea that soil, sand, and gravel was

1 different by saying, “any soil, sand, and gravel operation in existence at the time of the adoption
2 of these bylaws shall not be subject to the provision of these bylaws except that such operation
3 shall not extend beyond the then existing boundaries of the parcel.” Preston said they had
4 recognized that it was different back then. To Barre’s point, Hugh said if it wasn’t for the one
5 parcel, they probably wouldn’t have extraction operations in Res-2. Peter thought the high school
6 had 400,000 to 500,000 yards of gravel on it. Hugh said that was the one he was talking about, and
7 Peter said there was a parcel next to it and explained the high school and town both had parcels.
8 Hugh wondered if they should put those two parcels in Rural 5 where they probably will allow
9 extraction operations and the problem of Res 2 would go away. Barre said they were on the fence
10 on how to utilize the property and wanted the possibility of making it into housing. Hugh
11 understood and said the Selectboard’s guidance was to lean towards leaving it as gravel processing
12 until otherwise directed. Barre noted that Arne had been in attendance by Zoom but wasn’t any
13 longer. Hugh said if it turned out it was a perfect lot for affordable housing, they would figure out
14 how to deal with it. Barre wondered if it fell under conditional use and had to go before the
15 Development Review Board, why they didn’t have faith in it. Hugh said conditional use didn’t
16 mean the DRB could do whatever it wanted but rather there was a set of guidelines they must use
17 to decide and couldn’t say no if the parcel fit all the guidelines. Barre thought the guidelines would
18 be the differentiating factor. Peter suggested removing “rock quarry” from earth extractions.
19

20 Preston began to speak and was asked to use a different microphone. Sue used the opportunity to
21 mention to the commission that Arne had left the meeting immediately when Tim joined and
22 assumed it was so there wasn’t a quorum. Preston said conditional use means the DRB gets to set
23 conditions and they don’t often deny a use. If the applicant jumps through the right hoops they get
24 the use, even though it may have a boatload of conditions.
25

26 Jason had heard some interesting interpretations from lawyers and wondered how the town handled
27 community owned facilities. Jason wondered if they didn’t allow extraction if the two lots that
28 were community owned could come and ask for a permit for gravel extraction through that
29 limitation. Preston said he’s always taken the position that the town must follow the same rules as
30 everyone else, so the only time towns don’t is when the bylaws don’t require it. Preston said in
31 Woodstock and Killington, town properties weren’t subject to their sign ordinance. Chester doesn’t
32 do that. Preston added that towns are subject to Act 250. Jason said there is a statute that has
33 limitations on municipal bylaws and states that community owned and operated institutions and
34 facilities may be regulated with respect to location, size, etc. and has heard lawyers suggest that a
35 use doesn’t have to necessarily be in the table, and he wondered instead of splitting hairs over the
36 definition, if they could hang their hat on that. Peter said dimensional size rock was where most of
37 the problems were with Julian and as far as he was concerned, once you bring in raw material,
38 you’re manufacturing. Hugh thought they should add language to earth processing that implies
39 cutting, manufacturing, finished product, dimensional and something like that. Jason clarified that
40 earth operations included extraction and crushing of gravel. Hugh would be agreeable to leaving
41 extraction in Res 2, so they cover the two potential scenarios. Barre thought if they were happening
42 outdoors, there was more noise and problem but if it was indoors, it became a different situation.
43 Barre wanted to make sure they weren’t denying someone if it was indoors. Peter said there was
44 rock that was quarried in Chester and taken to Springfield Industrial Park to have it split and cut
45 up and loaded on pallets there. Cathy said in terms of noise, there was still a performance standard
46 that nobody was exempting, and Peter agreed. Hugh said they continue to play the card where

1 there is something on such a small scale that it represents home occupation or home business,
2 they'll be able to do it as long as they're not violating the performance standards. Preston said
3 Jason suggested extraction operations were allowed on municipal or school owned lands in that
4 district. People may view it as unfair, but it could be done. Hugh was agreeable to adjusting the
5 definitions to allow extraction operations in Res 2 anywhere. Hugh thought singling out the
6 municipality and implying they were special would send the wrong message. Hugh added the
7 gravel pit could possibly be a housing development in a year. Hugh wasn't worried if they allowed
8 extraction operation in Res 2 that there would be a ton of permits and was willing to underwrite
9 that risk. Jason clarified they were back to keeping extraction operation in Res 2 but not processing.
10 Jason would tweak the definitions of what they had discussed. Cathy asked if they were keeping
11 rock quarry in the extraction definition or making it separate. Peter suggested removing rock
12 quarrying. Hugh agreed. Peter said with rock quarrying, there is hammering and blasting. Cathy
13 and Peter saw rock quarry and extraction as two very distinct uses. Cathy added that totally
14 different equipment and process were used. Cathy couldn't find a universal standard and said in
15 some places, quarrying meant gravel and in others it meant dimensional stone. Peter said ASHE,
16 the organization of highway engineers, defined screen sizes and that was why he suggested screen
17 size. Peter said the State of Vermont Highway Standards define what bank run gravel is and a legal
18 definition that everyone uses and has been used in a million contracts. Jason pointed out they were
19 all fundamentally similar and it was really what the size of the operation was, how many trucks
20 were coming and going, the noise, and if it could be seen and heard by neighbors. Jason thought it
21 was all true but at the end of the day, it was the standards the DRB looked at and the conditions
22 they set that are the most important. Peter said if they said no drill, no rock hammer in the lower
23 conditions, it would draw the line. Hugh asked Peter if they left rock quarrying in the definition,
24 and part of the conditions were no blasting, drilling, or hammering, if it would make it a nonstarter?
25 Peter said it would put it back in the old days when holes were drilled by hand and filled with
26 water, and they waited for them to freeze. Barre said the Egyptians put dry cedarwood in the crack
27 and split it with water in the first version of hydraulics and made the pyramids. Hugh suggested
28 leaving rock quarries in the extraction operations because he didn't want to create a whole set of
29 separate definitions for quarrying and if they had to do something with the conditions, they would.
30 Cathy confirmed they would add cutting, shaping, and dimensional stone words to the processing.
31 Jason asked if there was any sense in adding a supplemental standard or something to gravel
32 operations language that said no blasting in Res 2. They agreed to try that. Hugh said the more
33 language they could add setting the tone of what they were trying to accomplish, even if it was a
34 supplemental standard, would give the DRB something to refer to.

35
36 Jason had a few questions on tiny houses and tiny house communities. He had looked at what other
37 towns had, and three towns treat tiny homes on wheels as RVs and generally allow them as a
38 temporary living accommodation and reminded him what Chester had decided about RVs and
39 would potentially allow them for a campground and Jason didn't think that's what the Commission
40 wanted. Jason said he and Preston agreed that many modern RVs and the tiny homes on wheels
41 are well insulated and maybe they should be considered. Jason wanted to make a distinction
42 between tiny houses on wheels and those on a permanent foundation. Lebanon and some other
43 towns have a cottage cluster standard. They could have language where they would allow for 8 if
44 water and wastewater rules and setbacks were met. The tiny homes on wheels were a little more
45 complicated. Barre wondered if a tiny house on wheels and RV were the same and should be
46 defined as an RV park and that may already exist, such as Horseshoe Acres. Barre was amazed

1 that people in Chester go to Horseshoe Acres, which is only 5 miles from Chester, to get away.
2 Barre thought if a tiny home was on wheels, it would be easy to say it should go in an RV park.
3 Barre liked the romantic idea of a tiny house settlement, especially if it was on town land and
4 thought it could be difficult setting rules for tiny houses on wheels and those that aren't.

5
6 Tim Roper said, in his mind, the primary difference between a tiny house and an RV is that the
7 RV has holding tanks and water tanks, so it's designed to be completely mobile whereas a tiny
8 home must be hooked up to local sewer and water supplies. Hugh thought that was a good point.
9 Jason said they could add language, like in Monkton, that said a travel trailer that's occupied and
10 connected to utilities: water, sewer, and electric for more than 180 days is basically a house and
11 treated as such. Jason said they could come up with a tiny home community where they must be
12 connected. Jason still felt uncomfortable and wanted to make sure they were okay with that
13 approach. Barre said if someone wanted to put a tiny house on a lot with the intent of it being there
14 for more than a season and would then be more of a dwelling at that point and thought Jason was
15 onto something with the suggested language. Preston said there are a handful of tiny houses in
16 Chester that have replaced mobile homes and are connected to septic, and people live in it and are
17 approved as houses. Hugh wasn't sure about RVs and was still considering that but thought most
18 people think about tiny homes as not seasonal whether it was on wheels or not. Hugh was fine with
19 that if it was treated as a dwelling or ADU and was properly permitted. Preston agreed and said
20 the only thing Jason and he discussed was the concept of a tiny home park is you can be closer
21 together than a 2-acre lot. As Peter had pointed out many times, mobile home parks are defined by
22 HUD and have their own set of rules and it seemed to Preston that tiny home parks were a form of
23 PUD. Hugh agreed. Jason and Hugh had discussed modifying the PUD regulations again to be
24 friendlier to tiny homes or use the PUD concept but call it a tiny home park. Peter said they had a
25 definition for a mobile home park that does all that if they removed the mobile home park. Peter
26 thought the biggest problem was they were calling for a minimum of 12,000 square feet per mobile
27 home and he thought it would allow for cluster dwellings. Peter thought they just needed to make
28 a few tweaks to 3.16 and could go there if it met the state regulations. Peter thought the minimum
29 12,000 square feet seemed like a lot. Barre asked Peter if he would change setbacks. Peter said the
30 setbacks were outside of the park, so the tiny homes had to meet the usual setbacks. Barre
31 understood but wondered if they wanted setbacks surrounding each tiny home so they weren't too
32 close together or too far apart or if they would leave it up to the developers. Hugh said it was a
33 good question but didn't know the answer. Hugh was a fan of creating a tiny house definition that
34 looked like the PUD definition but appropriate for some things Peter had mentioned. Hugh thought
35 if they could re-use 90% of the PUD language and it worked, fine. Hugh thought if it was carved
36 out, it could take its own path rather than constantly worrying about the definition of a mobile
37 home park or PUD. Hugh wasn't sure what that would look like and what the density would be
38 but once drafted, they could review it, a mobile home park, and a PUD and put all three together
39 and decide what looked right. As far as a tiny house for a place to live in Chester, Hugh didn't care
40 whether it had wheels. If someone was going to live in it full-time, it needed to be permitted as a
41 dwelling unit or ADU and follow the same rules. Hugh didn't want to see a situation where
42 someone bought a 1-acre lot and filled it with a bunch of tiny houses.

43
44 Barre didn't have a horse in the race, and they were there to make things happen but for the average
45 person to be able to do what was involved in a PUD, it was quite a bit and involved engineering.
46 Barre thought if they were trying to create more housing and density and this was one way, if there

1 was something they could do on a smaller scale like a primary dwelling and accessory dwelling,
2 they could have a few on one lot to make it work. Hugh said they had talked about having a second
3 ADU as a conditional use. Hugh thought if he bought a tiny house and placed it on his property
4 and was on town water and sewer and rented it out to someone to live, he would have an ADU.
5 Hugh said if he owned vacant land and put a tiny house on it and hooked it up to water and sewer
6 and lived there full-time, it was his dwelling and would require a permit and saw nothing wrong
7 with that. Hugh added they could figure out the RVs later because they may set a precedent with
8 tiny houses and may decide to fold RVs into that same precedent. Jason would try to come up with
9 language and they would look at it next time.

10
11 Jason asked if they had discussed tourist lodging and wondered if they had solutions. Jason asked
12 if they would differentiate tourist lodging to be more rural in character, size, and scope. Barre
13 wondered if Jason was talking about bed and breakfasts, inns, or short-term rentals. Jason said
14 tourist lodging was defined as overnight accommodation provided to transients for compensation,
15 including bed and breakfasts, boarding houses, inns, hotels, and other overnight accommodations
16 so it was everything. Jason wondered if they wanted a hotel in the middle of nowhere in Rural 8
17 District and thought they should differentiate what tourist lodging was allowed in rural areas.
18 Preston said they may run into an issue because there was a point where a short-term rental and
19 tourist lodge were getting blurred and currently, if the Selectboard decides to limit short-term
20 rentals, people may get a permit for a tourist lodge and then go through the DRB as a conditional
21 use. Preston said a tourist lodge isn't renting your entire house but renting 3 or more rooms so it's
22 like a small hotel. Preston didn't have the solution and said it was worth thinking about because
23 currently, tourist lodges are allowed everywhere because back in the old days, renting a room in
24 your house was a feelgood thing. Barre said some places are big buildings like his and can lend
25 themselves to it without any impact because they are utilizing current structures. Building a bigger
26 inn on the edge of town would require a large septic system which would limit it. Some things are
27 self-limiting and that's why they had less, according to Barre, who would support someone turning
28 a bigger structure into an inn if they upgraded the septic to make it happen. Hugh wondered if
29 tourist lodging was allowed in most zones whether permitted or as a conditional use and Cathy
30 didn't think it was ever permitted. Preston thought in most zones it was a conditional use. Jason
31 agreed and said they weren't allowed in general business, open space, or residential. They had
32 talked about allowing it in Rural 8 and thought it may be self-limiting because of septic and
33 wondered if they wanted to limit the size in the most rural of districts. Barre thought if they
34 considered possibilities for existing places, like the land on the corner of 10 and 103, and if
35 someone put a cool looking inn there and supported the infrastructure, it could be good for the
36 town on a big lot that's flat. Barre didn't know where else you could put someplace like that. To
37 support what Barre was saying, Hugh said he was looking at tourist lodging, and it would be fine
38 if it was a conditional use in Res 2 and possibly Rural 5 but wasn't convinced. In Res 2, there was
39 already what used to be Town Farm Inn that at one time, was probably permitted as tourist lodging
40 so he thought it was appropriate. Preston had said earlier that they may want to spend the time
41 making sure they had the right definition for tourist lodging because if it was their intention to
42 create a definition that would not allow a short-term rental to be classified as tourist lodging, if
43 that's what they thought best, they could make sure the definition for tourist lodging didn't
44 facilitate that. Jason said they could look at that but wondered what the difference was. If Jason
45 created a bed and breakfast, he would be renting rooms for short durations and wondered if it
46 mattered if he was doing it the old-fashioned way or through Airbnb. Hugh said it had nothing to

1 do with the platform, but currently a permit wasn't necessary to run an Airbnb. Jason wondered if
2 he had a permit for a bed and breakfast, would it matter how he marketed it. Hugh said if he got a
3 permit for tourist lodging but advertised on a short-term rental platform, he didn't have an issue
4 with that. Peter thought the state's definition for tourist lodging was different because they test the
5 water and Airbnb didn't require water testing, but official tourist lodging would. Preston said the
6 state requires inspection for 3 rooms or more and could include water, but he wasn't sure. Preston
7 said the current ordinance for short-term rentals allows anyone who's been approved as a tourist
8 lodge to advertise on the host sites and doesn't require registration. Preston was concerned that
9 back when it was easy to get a registration, it wasn't a problem but if they enacted a waiting period,
10 they needed to make sure their definition of tourist lodging was tighter. Hugh agreed because if
11 people couldn't get a registration for a short-term rental, they would apply for a permit for tourist
12 lodging and Preston was fearing that. Barre said the good of it was the problem with short-term
13 rentals most people had were with the unhosted, and tourist lodging was always hosted. Preston
14 disagreed and said that was the problem. Barre asked how it was unhosted if it was like a bed and
15 breakfast and Preston said they have someone there cooking breakfast but not all tourist lodgings
16 were bed and breakfasts. Preston said people do remote check-ins now and wasn't quite what it
17 used to be. Preston said he and Jason had both been to hotels where there was no staff, and you
18 receive a code on your phone to open the door. Hugh recommended looking at the definitions,
19 leaving tourist lodging as a conditional use in Res 2 and Residential Mixed-Use and he would be
20 inclined to leave it in Rural 5 but not in R-8 or Conservation. Jason asked the other members'
21 thoughts on that. Peter said there were a lot of short-term rentals in Rural 8 and Hugh responded
22 they could be there but just couldn't be a tourist lodge and Jason agreed. Peter thought it would be
23 interesting to have the two different definitions and wondered where the line was. Barre asked if
24 there was a difference in the number of rooms allowed between short-term rentals and tourist
25 lodging. Preston said the line was a tough one but most of the time when you're doing a short-term
26 rental, you're renting the whole house but when you're doing tourist lodging, you're renting three
27 or more rooms and were basically a mini hotel. Hugh thought they should give it a try and Preston
28 said they should at least have a better definition than the current one.

29
30 Jason said they had addressed most of his questions but the main one remaining was if they had
31 looked at the other stuff and had anything else jumped out at them. Hugh thought in their recent
32 work they had done that they were getting close to having Res 2 worked out and Rural Mixed Use
33 worked out but didn't think they had really looked at Rural 5, Rural 8, and Conservation. Jason
34 agreed with that. With Rural Mixed Use, Jason believed he had done what they had asked and split
35 apart automotive sales and service from automotive fuel. Jason said in Rural Mixed Use, they were
36 now allowing automotive sales and service but not fuel and wondered if he had captured it
37 correctly. Hugh thought he had. Peter said they were basically saying in Gassetts, you couldn't
38 have a gas station where as many as 3 had previously existed. The corner of Route 10 and 103 has
39 enough land to spread out and they were saying you couldn't do that there. Barre agreed it would
40 be a good place for one. Hugh thought the only reason they had started down that road, and he
41 would be happy to revisit it, was they went to a place that said every time you go to auto fuel sales,
42 you end up with a few gas pumps and a huge convenience store and that may not be what they
43 want. Peter said that was the one place in town where they could easily have it. Barre said on the
44 news, they talked about dollar stores going under and one of the things towns had done in zoning
45 was restricting how close dollar stores could be to each other. Barre thought if they had the distance
46 requirement, like a mile, they would be on the edge of town and could solve the problem. Hugh

1 was remembering more about the discussion and said they allow a fueling station in Village Mixed
2 Use so it seemed like they should allow one in Rural Mixed Use. Peter said they were putting the
3 Motel in the Meadow and Armory in the same location as Gassetts and they were a little different.
4 Hugh agreed. Peter said the Motel in the Meadow people would really like to do something with
5 their land housing wise and had discussed it at town meeting. Peter said there were limiting factors
6 in Gassetts where it was clay and would prevent having a big sewer system but on the other hand,
7 it was a place tractor trailers could pull over. Peter said a classic problem they had with Chat &
8 Chew was they had to make it no parking because tractor trailers parked in front of people's houses
9 and walked across the street to the diner. The same issue was with the diner below town with
10 tractor trailer parking. Peter said the only piece of land that wasn't in the floodplain on Route 103
11 was right there or they could decide, as a town, that was something they never wanted to do. Jason
12 said there were 3 areas in the rural part of town so whatever rules they allow for, will potentially
13 be able to happen in those 3 spots and as he understood it, they added automotive service because
14 there's an existing use in Gassetts. Jason wondered if they wanted automotive fuel there also and
15 said they could have a further conversation and noted fuel may be more EV charging stations
16 tomorrow and other fuel sources. Barre thought it would be a long time before that happened.
17 Jason said they could exempt EV charging stations. Barre said they were trying to facilitate things
18 to make the town better and a lot of times they were behind the eightball and was why they have
19 weird parking and lose nice buildings, and why the town didn't look as good as it did before he
20 moved to Chester. Barre thought it would be nice if they had a place for tractor trailers to fill up
21 and tourists to turn around like on the interstate and thought it would be nice having something
22 like that on the end of town, so tractor trailers didn't have to park alongside the road. Cathy said
23 when the public safety building was built, tractor trailers lost a great place for reversing direction,
24 and she felt bad about it but didn't see another choice. Barre suggested something on the internet
25 to tell truckers that they could go down his road to turn around and Peter said there was a weight
26 limit on that road, but Barre said they go down it every day to the grain store. Hugh stood by their
27 rationale for splitting the definitions because of fuel sales and the amount of traffic generated and
28 things that happen around a convenience store with a gas station was much different than a Mom
29 and Pop that does car repair. Hugh wasn't wavering on the fact they split the definitions and if
30 they weren't able to figure out where to put the zoning part of it, they may need to think about it
31 more. Hugh's first thought was to allow a gas station in that part of Gassetts but then they would
32 have to look at all the other red areas on the map to see if one could go there. Cathy very much
33 liked splitting the two uses and thought allowing a refueling station of some type in Gassetts was
34 a great idea and another place where they may be able to have a tractor trailer turnaround because
35 it is flat and not too marshy. Cathy added the map didn't have Rural Mixed Use versus Village
36 Mixed Use and thought some of the red on it they were intending to make Village. Jason said the
37 Rural Mixed Use was Gassetts, out by Motel in the Meadow, and the southern end of town by
38 Silvan Road. Cathy said out by Motel in the Meadow was another open flat space. Jason asked if
39 they wanted an automotive fuel sales facility that had a convenience store and a fast-food place in
40 it. Cathy said a little further west on Route 11, there was at least one gas station, Jelly's, that was
41 no longer open. Peter agreed and said it was a 24-hour station. Barre said the snowmobilers have
42 a problem with accessibility to fuel and other conveniences and Cathy agreed. Barre said having a
43 place where there was fuel, an eatery, and a place to stay where the Motel in the Meadow could be
44 cool for tourism for the town. Peter said Stone Hearth has fuel too. Barre didn't think they had
45 filled out the proper paperwork for it. Cathy thought they should keep the piece on 11 West and

1 allow it there. They said Jelly's was in Andover and over the line. Hugh said if it was up to him,
2 he would make fuel a conditional use in Rural Mixed Use.

3
4 Jason said in Rural Mixed Use, he hadn't added extraction or processing and asked if anything
5 looked off to them for uses in the district. Jason had added pub and bar, personal service shop, and
6 open market. Cathy wondered if they wanted to make art studio and/or gallery a use there and
7 Jason said he had added it based on their conversation the last time. Hugh was okay with what he
8 saw and was okay with Res 2 and Rural Mixed Use. Jason noted they were allowing restaurants
9 and wondered if there was any reason to discuss formula type uses or drive-thrus. Hugh thought
10 they had decided at the last meeting not to block out formula businesses or bigger/industrial type
11 buildings and didn't have great reasons to block it out everywhere. Jason wondered about a
12 McDonald's scenario. It may not be likely, but Jason could imagine a convenience store and some
13 place with a drive thru. Cathy said the Sunoco station was going to be a drive-thru for Dunkin'
14 Donuts but gave up and she thought mostly because it was in the floodplain. Hugh wondered if
15 they had the discussion about restaurant not being allowed in Res 2 and they had. The only reason
16 Hugh was asking was Town Farm Inn had been a restaurant. Jason thought they had discussed it
17 but said nothing was written in stone so they could discuss it again and add it if they wanted. Hugh
18 was fine with leaving it out.

19
20 There was nothing else for Residential 2.

21
22 Hugh said at a future meeting, they should tackle looking at sawmill and wood processing and
23 make sure they had it like they want it. They had accomplished a lot at this meeting but there was
24 homework for Jason and Preston to tweak things for the next meeting.

25 26 **Agenda Item 4, Adjournment**

27
28 Cathy moved to adjourn, and Barre seconded. A vote was taken, and it passed unanimously. The
29 meeting was adjourned at 8:05 p.m.

LEGEND:

- EXISTING / PROPOSED POWER POLE
- EXISTING GRADE CONTOUR LINES (5 FOOT INTERVALS)
- EXISTING GRADE CONTOUR LINES (1 FOOT INTERVALS)
- EXISTING OVERHEAD POWER LINES
- APPROXIMATE PROPERTY LINES
- APPROXIMATE PROJECT PROPERTY LINES
- SETBACKS TO SOLAR PANEL RACKING
- WETLANDS (LOCATED BY AE)
- WETLAND BUFFER
- STREAM (LOCATED BY AE)
- STREAM TOP OF BANK (LOCATED BY AE)
- RIPARIAN BUFFER
- RTE PLANTS (LOCATED BY AE)
- MAPPED SOIL BOUNDARY (VCGI)
- DEER WINTERING AREA BOUNDARY (VCGI)
- RIVER CORRIDOR (VCGI)
- 100-YEAR FLOOD LIMITS (VCGI)
- PROPOSED UNDERGROUND POWER
- PROPOSED OVERHEAD POWER
- PROPOSED PERIMETER FENCE
- PROPOSED FIXED SOLAR PANEL RACKING
- PROPOSED STAGING AREA
- PROPOSED CLEARING AND LIMIT OF DISTURBANCE (LOD)

- NOTES:**
- BACKGROUND IMAGERY IS 2022 ORTHOGRAPHIC PHOTOS FROM THE VERMONT CENTER FOR GEOGRAPHIC INFORMATION (VCGI).
 - THE HORIZONTAL COORDINATE SYSTEM IS BASED ON NAD83 VERMONT STATE PLANE 4400 (US SURVEY FEET). ELEVATIONS ARE BASED ON THE NAVD88 (US SURVEY FEET).
 - EXISTING GROUND ELEVATIONS ARE BASED ON 2016 LIDAR DATA FROM VCGI. EXISTING ENVIRONMENTAL FEATURES SHOWN WERE DELINEATED AND LOCATED BY ARROWWOOD ENVIRONMENTAL (AE) IN SEPTEMBER 2023.
 - EXISTING UTILITIES SHOWN ARE NOT WARRANTED TO BE COMPLETE OR ACCURATE. CONTRACTOR SHALL CONTACT DIG SAFE BEFORE BEGINNING ANY EXCAVATION.
 - THIS IS IN NO WAY A BOUNDARY SURVEY. PROPERTY LINES SHOWN ARE BASED ON TAX MAP INFORMATION PROVIDED BY THE TOWN.
 - THIS IS A PRELIMINARY DESIGN PLAN. FINAL DESIGN WILL BE MODIFIED TO MATCH EQUIPMENT PURCHASED AND POSSIBLE PERMIT CONSTRAINTS REVEALED DURING PROJECT'S REVIEW.
 - THE APPROXIMATE LIMIT OF DISTURBANCE (LOD) SHOWN ON THIS PLAN IS ±21.6 ACRES. THE APPROXIMATE SOLAR ARRAY FOOTPRINT IS ±10.6 ACRES.

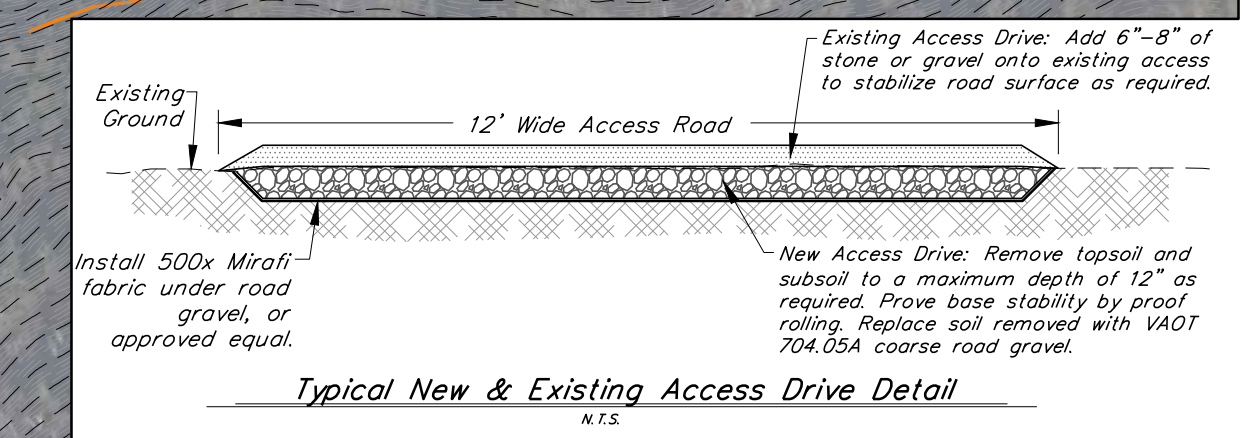
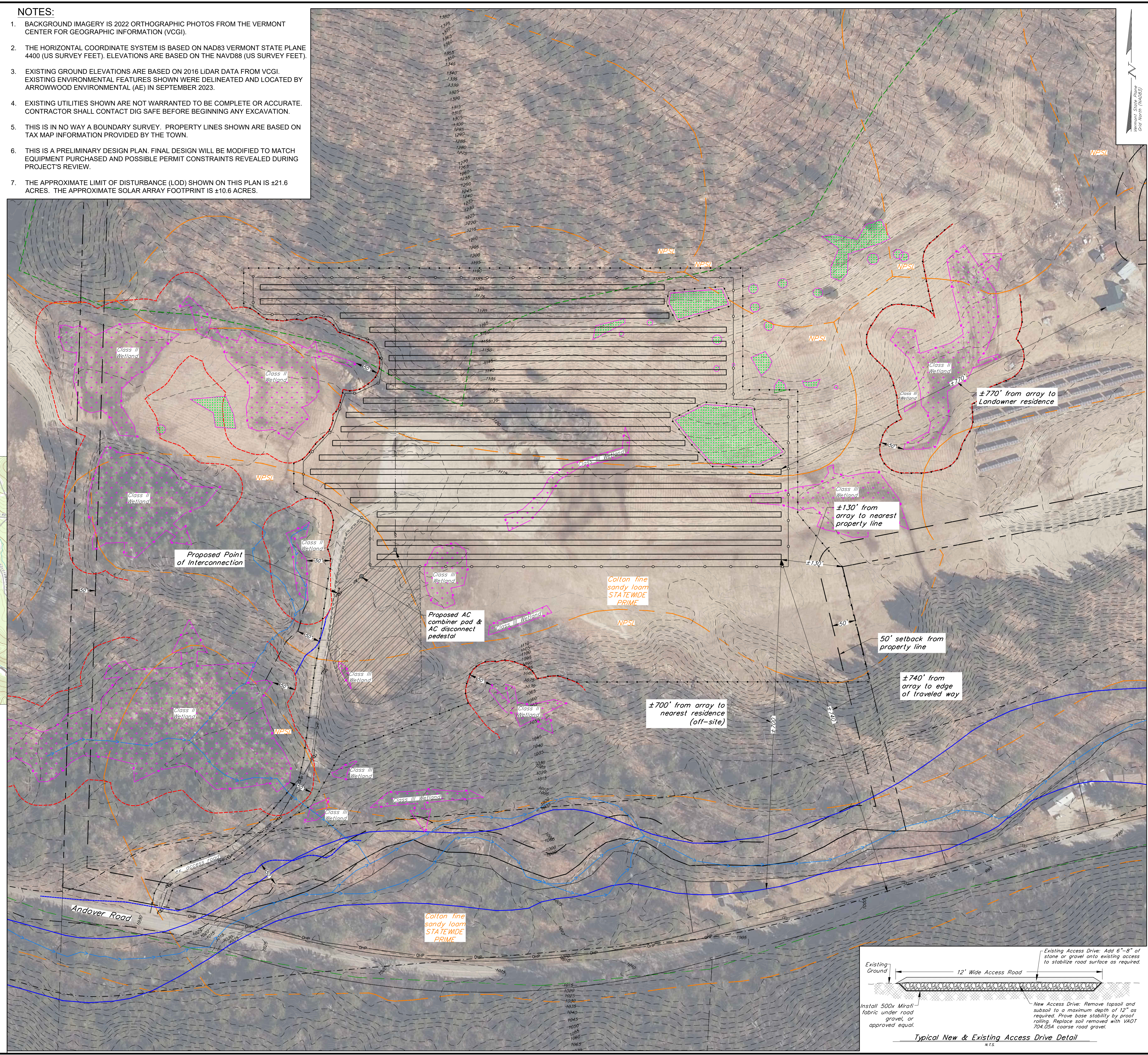
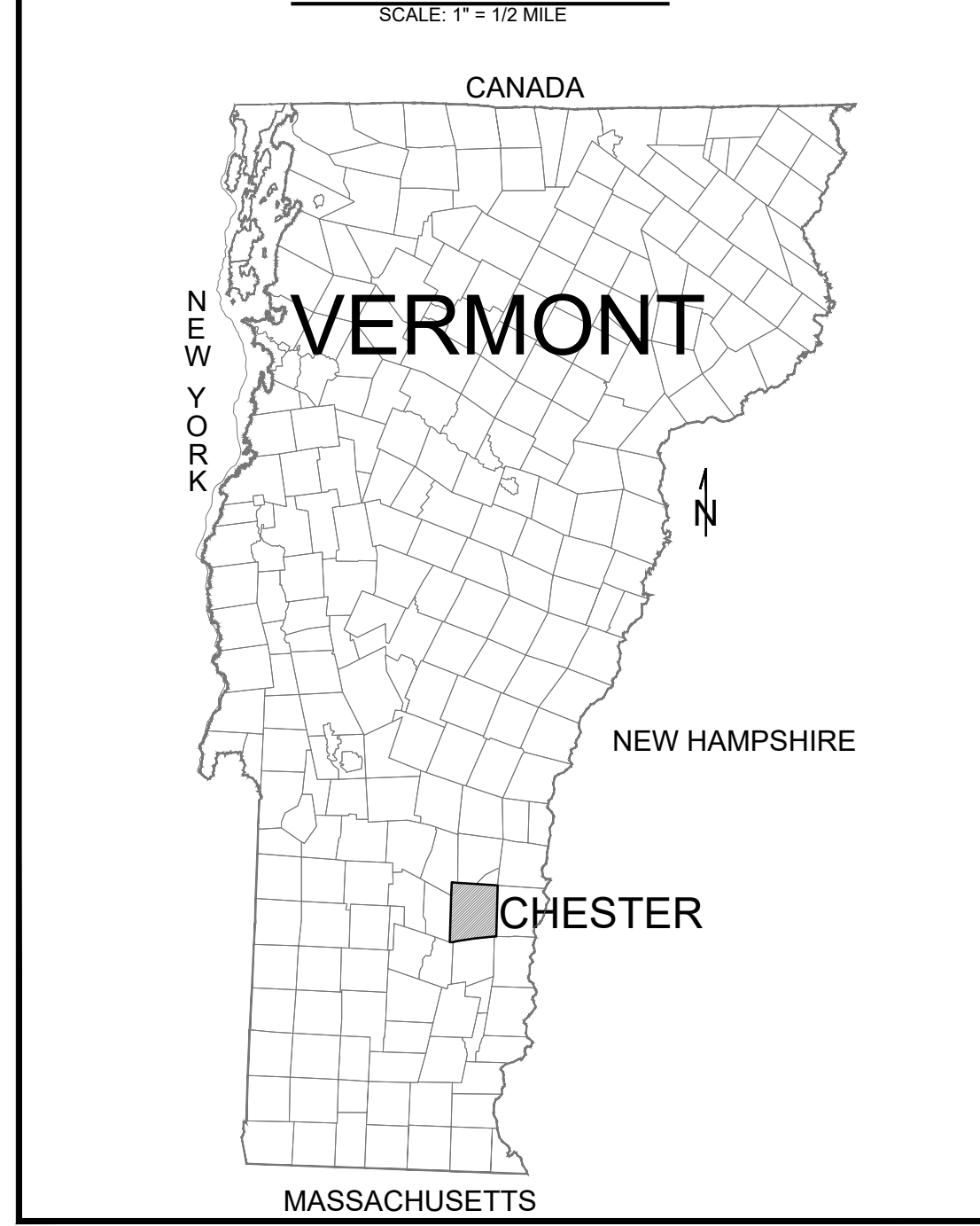
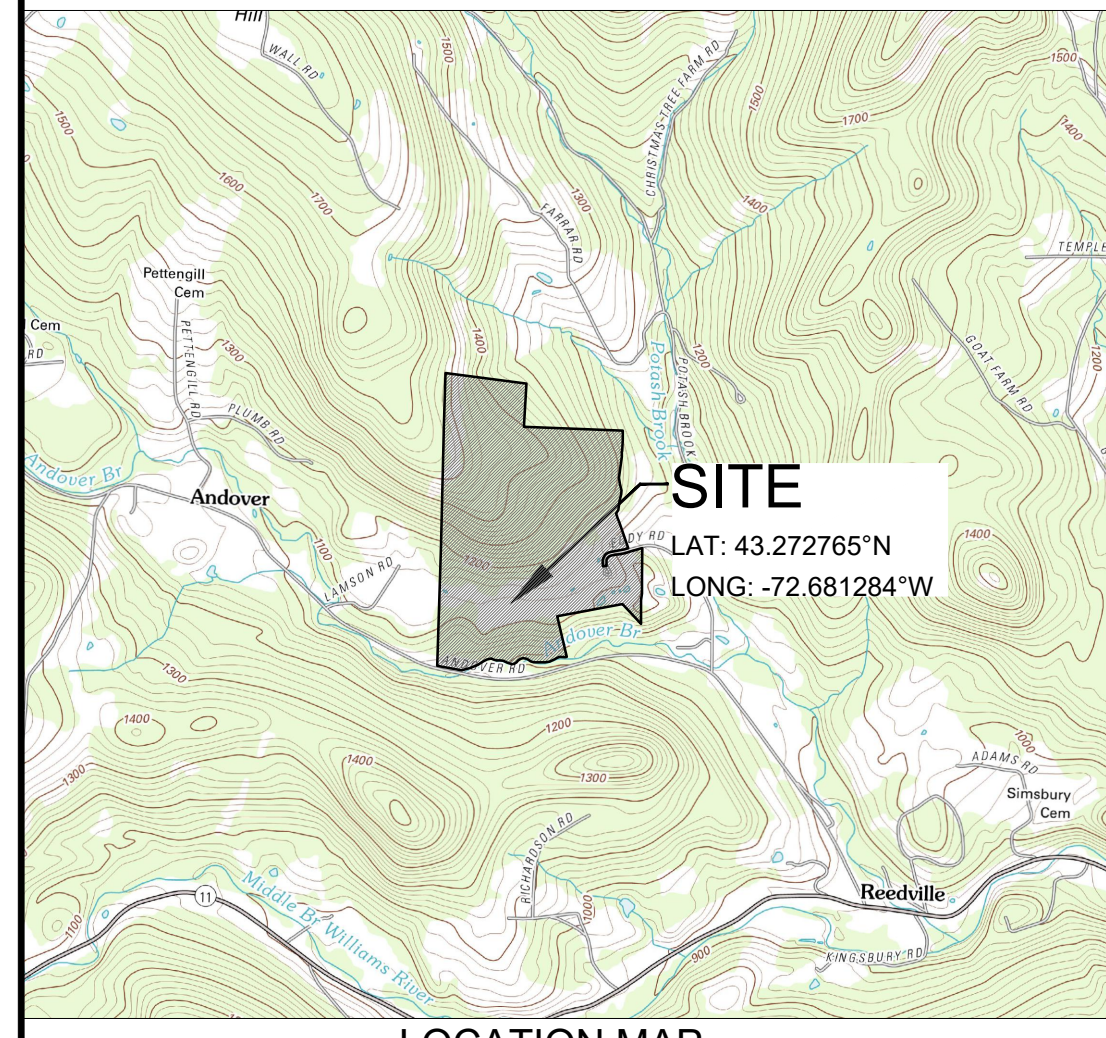

Chester Andover Solar LLC

Andover Road
Chester, Vermont

NORWICH SOLAR TECHNOLOGIES
15 RAILROAD ROW, SUITE 101
WHITE RIVER JUNCTION, VERMONT 05001
802.283.3228
WWW.NORWICHSOLAR.COM

THIS DOCUMENT IS THE PROPERTY OF NORWICH SOLAR TECHNOLOGIES. NO INDICENT REPRODUCTION OR MODIFICATION WITHOUT WRITTEN PERMISSION IS PROHIBITED.

KREBS & LANSING CONSULTING ENGINEERS
164 Main Street, Suite 201
Colchester, Vermont 05446
P: (802) 878-0375
www.krebsandlansing.com

**ISSUED FOR PERMIT REVIEW
NOT FOR CONSTRUCTION**

SOURCE DATA LEGEND

MAPPING SOURCE DATA USED FOR PLAN COMPILATION

Electrical Design:
Norwich Solar Technologies
15 Railroad Row
White River Junction, Vermont 05001

Civil Engineering:
Krebs and Lansing Consulting Engineers, Inc.
164 Main Street, Suite 201
Colchester, Vermont 05446

Environmental:
Arrowwood Environmental
950 Bert White Rd
Huntington, Vermont 05462

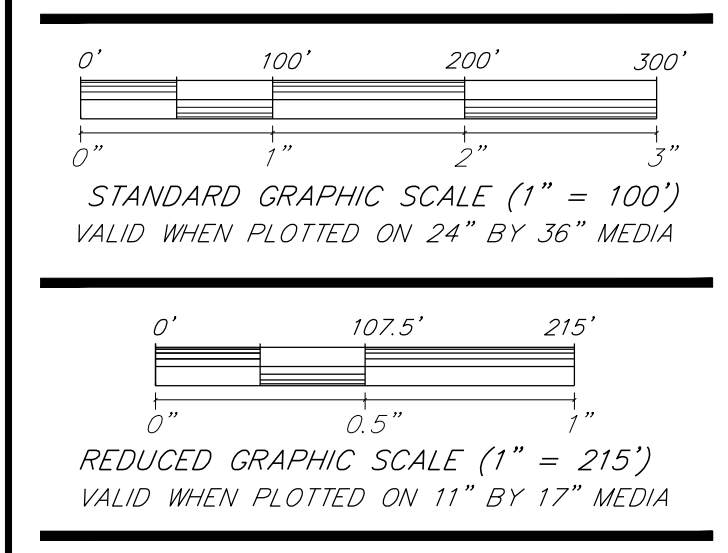

Proposed Solar Array

SET/REV	REVISIONS/COMMENTS	DATE

Drawing Title:
PRELIMINARY SITE PLAN

DATE of Issue: 3/07/2024
Drawn by: JBC
Checked by: JBC
Project No.: 24135
Scale: 1" = 100'
Drawing No.:
Rev No.:

C-100

UNIFIED DEVELOPMENT BYLAWS TOWN OF CHESTER, VERMONT



ADOPTED MARCH 15, 2017	EFFECTIVE APRIL 5, 2017	
AMENDED JUNE 1, 2022	EFFECTIVE JUNE 22, 2022	(Added Village Green District)
AMENDED SEPT. 21, 2022	EFFECTIVE OCTOBER 12, 2023	(Added Adaptive Reuse)
AMENDED OCTOBER 5, 2022	EFFECTIVE OCTOBER 26, 2023	(Added Legacy Uses)
AMENDED JULY 5, 2023	EFFECTIVE JULY 26, 2023	(Admin. Amendments, Open Space)
AMENDED DEC. 6, 2023	EFFECTIVE DEC. 27, 2023	("Chester Center Districts")

Draft Rural Amendments April 10, 2024

ARTICLE 2 – Establishment of Zoning Districts & District Standards

2.1 Classes of Districts

For the purposes of these Bylaws, the boundaries of districts are and shall be established as shown on the Zoning Map of the Town of Chester, which map is hereby declared to be part of these Bylaws, and the area of the Town of Chester is hereby divided into the following classes of districts:

VC - Village Center

VG - Village Green

VMU – Village Mixed Use

GB - General Business

SV - Stone Village

N – Neighborhood

Residential 2 Acres (RES-2) ~~R40 – Residential 40,000 square foot lots~~

RMU – Rural Mixed Use ~~A3 – Adaptive 3~~

Rural 5 Acres (RUR-5) ~~R120 – Residential 120,000 square foot lots~~

OS – Open Space District

Rural 8 Acres (RUR-8) ~~CR – Conservation Residential~~

Conservation F – Forest

APO - Aquifer Protection Overlay District

FDP - Flood Damage Prevention Overlay District

A full and detailed written description of the precise boundaries of all districts, which is a part of these Bylaws, is on file with the Town Clerk of the Town of Chester.

2.2 District Uses and Requirements

The following are district uses, lot size minimums, setbacks, frontage requirements and maximum coverage.

A. Permitted Uses

Permitted uses are those uses that can be approved by the Zoning Administrator (ZA), without action of the Development Review Board. All permitted uses shall comply with the Parking and Sign Requirements for the District.

B. Conditional Uses

Specific Conditional Uses are permitted in each district only by approval of the Development Review Board provided that the general and specific standards and special criteria outlined in Section 4.7 of these Bylaws are met.

CHESTER UNIFIED DEVELOPMENT BYLAWS

2.8 Residential **2-Acre (RES-2) 40,000 (R40)** District

A. Purpose: To provide moderate-density residential neighborhoods with compatible commercial and civic uses that are consistent with the Chester Town Plan.

B. Permitted Uses: The following land uses require a zoning permit issued by the Zoning Administrator (see Section 7.2):

1. Accessory Dwelling
2. Accessory Structure
3. Accessory Use (e.g., Home Child Care Facility, ~~Home Occupation~~)
4. Agricultural/Forestry (See Sec. 4.3 Exemptions)
5. **Dwelling** – Single- and Two-**Household**
6. Family Child Care Home
7. Group Home
8. Home Occupation

C. Conditional Uses: The following land uses require conditional use review by the Development Review Board (see Section 4.8) and a zoning permit issued by the Zoning Administrator (see Section 7.2):

1. ~~Animal Hospital~~
2. ~~Animal Kennel~~
3. ~~Building and Construction Trades~~
4. **Art Studio and/or Gallery**
5. Campground
6. Civic / Institutional
7. ~~Commercial Storage Unit~~
8. **Dwelling** – Multi-**Household**
9. **Earth** Extraction Operations
10. Family Child Care Facility
11. Food Truck/Food Cart/Food Stand
12. ~~Heavy Construction Trades~~
13. Home Business
14. Mobile Home Park
15. ~~Nursery~~
16. ~~Processing Construction and Landscaping Aggregate~~
17. Professional Office
18. Recreation
19. **Tiny House Community**
20. Tourist Lodging
21. Wireless Communication Facility
22. ~~Wood Processing~~

CHESTER UNIFIED DEVELOPMENT BYLAWS

D. Dimensional Standards:

Minimum Lot Size	2 Acres 40,000 (87,120 sq. ft.)
Minimum Lot Frontage	120 150 ft.
Minimum Front Yard Setback	40 ft.
Minimum Side Yard Setback	30 ft.
Minimum Rear Yard Setback	30 ft.
Maximum Lot Coverage	20%
Maximum Building Height	35 ft.

E. Supplemental Standards:

1. Driveways. All new driveways and substantially reconstructed existing driveways along VT Routes 11 and 103 shall meet the Agency of Transportation's *Access Management Program Guidelines*, as most recently adopted.

2. Character of Development. New development and modifications to existing buildings and uses shall be consistent with the existing character of the area and compatible with adjacent land uses with respect to traffic, noise, vibrations, or other impacts in conflict with residential uses.

3. Landscaping and Screening. The Development Review Board shall require landscaping or other screening between incompatible uses or structures.

4. Earth Extraction Operations. Blasting, hammering, drilling and similar noisy activities that are customary at stone quarries and are not appropriate in residential areas are prohibited in this District. Earth extraction operations in this District allow, for example, for gravel pits, which typically involves extraction and crushing material that fits through a 24 inch sieve.

CHESTER UNIFIED DEVELOPMENT BYLAWS

2.9 Rural Mixed Use (RMU) District ~~Adaptive 3 (A3) District~~

A. Purpose: To allow for moderate density, mixed use development in three small clusters of existing development located along major thoroughfares. All new development, redevelopment and infill development will employ sound access management techniques and incorporate smart growth principles as defined in state law [24 V.S.A. § 2791]. ~~provide property owners in this lower density district, who are served by municipal water but not municipal sewer, the opportunity to take advantage of existing facilities as well as have potential for the creation of commercial and light industrial uses.~~

B. Permitted Uses: The following land uses require a zoning permit issued by the Zoning Administrator (see Section 7.2):

1. Accessory Dwelling
2. Accessory Structure
3. Accessory Use (e.g., Home Child Care Facility, ~~Home Occupation~~)
4. Agricultural/Forestry (See Sec. 4.3 Limitations & Exemptions)
5. Dwelling Residential – Single- and Two-Household Family
6. Family Child Care Home
7. Group Home
8. Home Occupation
9. Private Broadcast Facility

C. Conditional Uses: The following land uses require conditional use review by the Development Review Board (see Section 4.8) and a zoning permit issued by the Zoning Administrator (see Section 7.2):

1. Animal Hospital
2. Animal Kennel
3. Art Studio and/or Gallery
4. Arts & Entertainment
5. Automotive Service/Sales
6. Automotive Fuel
7. ~~Building and Construction Trades~~
8. ~~Campground~~
9. Civic/Institutional
10. ~~Commercial Broadcast Facility~~
11. Commercial Storage Unit
12. Dwelling Residential – Multi-Household Family
13. Family Child Care Facility
14. Food Truck/Food Cart/Food Stand
15. Health Care Facility ~~Heavy Construction Trades~~
16. Home Business

CHESTER UNIFIED DEVELOPMENT BYLAWS

- 17. Light Industrial
- 18. Mobile Home Park
- 19. Multi-Purpose
- 20. Nursery
- 21. Open Market
- 22. Personal Service Shop
- 23. Professional Office
- 24. Pub/Tavern/Bar
- 25. Recreation
- 26. Residential Care Home
- 27. Restaurant
- 28. Retail Store
- 29. Tourist Lodging
- 30. Wood Processing

D. Dimensional Standards:

Minimum Lot Size	2 3 acres
Minimum Lot Frontage	150 200 ft.
Minimum Front Yard Setback	40 50 ft.
Minimum Side Yard Setback	30 50 ft.
Minimum Rear Yard Setback	30 50 ft.
Maximum Lot Coverage	30 35 %
Maximum Building Height	35 ft.

E. Supplemental Standards:

1. Character of Development. New development and redevelopment in this area shall continue in the current moderate density, with a mix of commercial, light industrial and residential uses.

2. Driveways. All new driveways and substantially reconstructed existing driveways shall meet the Agency of Transportation's *Access Management Program Guidelines*, as most recently adopted.

CHESTER UNIFIED DEVELOPMENT BYLAWS

2.11 Rural 5 Acre (RUR-5) Residential 120,000 (R120) District

A. Purpose: To provide for the rural countryside and working landscape activities, while also accommodating low-density residences and home businesses neighborhoods with compatible home businesses and working landscape uses that are consistent with the Chester Town Plan.

B. Permitted Uses: The following land uses require a zoning permit issued by the Zoning Administrator (see Section 7.2):

1. Accessory Dwelling
2. Accessory Structure
3. Accessory Use (e.g., Home Child Care Facility, ~~Home Occupation~~)
4. Agricultural/Forestry (See Sec.4.3 Limitations & Exemptions)
5. Dwellings – Single- and Two-Household
6. Family Child Care Home
7. Group Home
8. Home Occupation

C. Conditional Uses: The following land uses require conditional use review by the Development Review Board (see Section 4.8) and a zoning permit issued by the Zoning Administrator (see Section 7.2):

1. Animal Hospital
2. Animal Kennel
3. Art Studio and/or Gallery
4. Building and Construction Trades
5. Campground
6. Civic Institutional
7. Dwellings – Multi-Household
8. Earth Extraction Operations
9. Earth Processing Operations
10. Family Child Care Facility
11. Food Truck/Food Cart/Food Stand
- ~~12. Heavy Construction Trades~~
13. Home Business
14. Mobile Home Park
15. Nursery
16. Professional Office
17. Recreation
18. Sawmill
19. Tourist Lodging
20. Wireless Communication Facility
21. Wood Processing

CHESTER UNIFIED DEVELOPMENT BYLAWS

D. Dimensional Standards:

Minimum Lot Size	3 acres
Maximum Density	1 blg. unit / 5 acres
Minimum Lot Frontage	150 200 ft.
Minimum Front Yard Setback	40 50 ft.
Minimum Side Yard Setback	30 50 ft.
Minimum Rear Yard Setback	30 50 ft.
Maximum Lot Coverage	20 10 %
Maximum Building Height	35 ft.

E. Supplemental Standards:

1. Driveways. All new driveways and substantially existing driveway shall meet the AOT Access Management Program Guidelines and/or the Town of Chester Road & Bridge Specifications.

2. Character of Development. New development and modifications to existing buildings and uses shall be consistent with the existing character of the area and compatible with adjacent land uses with respect to traffic, noise, vibrations, or other impacts in conflict with residential uses.

3. Landscaping and Screening. The Development Review Board shall require landscaping or other screening between incompatible uses or structures.

4. Dimensional Standards. Please note that the former minimum lot size was deleted in the 2024 amendment. It was replaced with a maximum density standard. In this district, a maximum density of 1 building unit (i.e., one single-household dwelling, one multi-household dwelling) per 5-acres shall not be exceeded. As an example, a property owner that wants to subdivide a 20-acre lot could create four conventional 5-acre lots (see Figure X.1). Or, that property owner could instead create three 2-acre lots and maintain one 14-acre lot, which can no longer be subdivided (see Figure X.2). The benefit of this second approach is providing flexibility to create smaller, lower-cost lots for housing, maintaining a larger lots to reduce forest fragmentation, and maintaining an overall low density in this rural district.

CHESTER UNIFIED DEVELOPMENT BYLAWS

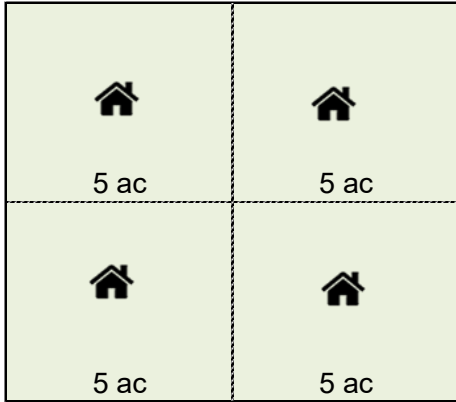

Figure X.1: Minimum Lot Size

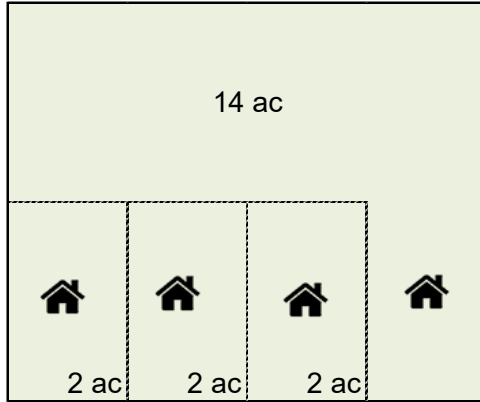

Figure X.2: Maximum Density

CHESTER UNIFIED DEVELOPMENT BYLAWS

2.12 Rural 8-Acre (RUR-8) ~~Conservation Residential (C-R)~~ District

A. Purpose: To ~~conserve~~ maintain large parcels or tracts of land ~~that are valuable~~ for working landscape related uses, including farming and forestry. In keeping with the Town Plan goals to retain rural character as well as to serve as habitat for wildlife and outdoor recreational uses, these areas are designated for very low-density development. This may be accomplished through cluster development or development for residential purposes of that land that is marginal for agricultural use.

B. Permitted Uses: The following land uses require a zoning permit issued by the Zoning Administrator (see Section 7.2):

1. Accessory Dwelling
2. Accessory Structure
3. Accessory Use (e.g. Home Child Care Facility, Home Occupation)
4. Agricultural/Forestry (See Sec. 4.3 Limitations & Exemptions)
5. Dwelling— Single- and Two-Household
6. Family Child Care Home
7. Group Home
8. Private Broadcast Facility

C. Conditional Uses: The following land uses require conditional use review by the Development Review Board (see Section 4.8) and a zoning permit issued by the Zoning Administrator (see Section 7.2):

1. Animal Kennel
2. Art Studio and/or Gallery
3. Building and Construction Trades
4. Campground
5. Civic/Institutional
6. Commercial Broadcast Facility
7. Earth Extraction Operations
8. Earth Processing Operations
9. Family Child Care Facility
10. Heavy Construction Trades
11. Home Business
12. Nursery
13. Recreation
14. Sawmill
15. Wood Processing

D. Dimensional Standards:

Minimum Lot Size	5 acres
------------------	---------

CHESTER UNIFIED DEVELOPMENT BYLAWS

Maximum Density	1 blg. unit / 8 acres
Minimum Lot Frontage	200 250 ft.
Minimum Front Yard Setback	40 50 ft.
Minimum Side Yard Setback	30 50 ft.
Minimum Rear Yard Setback	30 50 ft.
Maximum Lot Coverage	10%
Maximum Building Height	35 ft.

E. Supplemental Standards:

1. Dimensional Standards. Please note that the former minimum lot size was deleted in the 2024 amendment. It was replaced with a maximum density standard. In this district, a maximum density of 1 building unit (i.e., one single-household dwelling, one two-household dwelling) per 8-acres shall not be exceeded. As an example, a property owner that wants to subdivide a 32-acre lot could create four conventional 8-acre lots (see Figure X.1). Or, that property owner could instead create three 2-acre lots and maintain one 26-acre lot, which can no longer be subdivided (see Figure X.2). The benefit of this second approach is providing flexibility to create smaller, lower-cost lots for housing, maintaining a larger lots to reduce forest fragmentation, and maintaining an overall low density in this rural district.

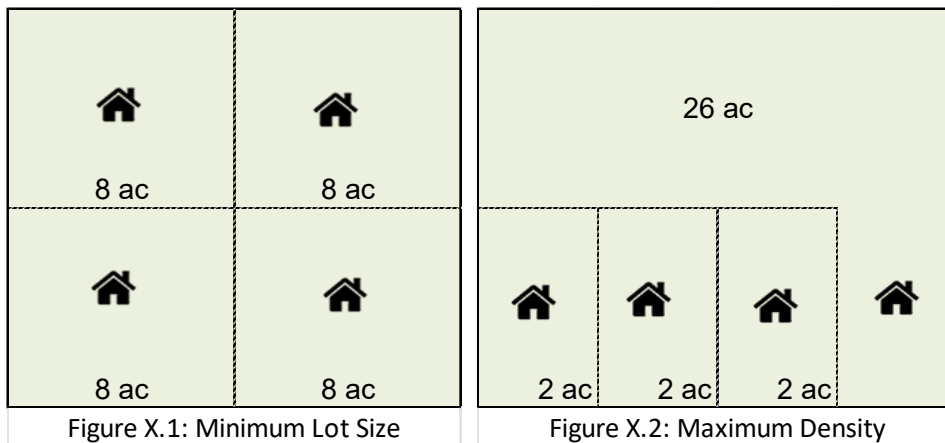

CHESTER UNIFIED DEVELOPMENT BYLAWS

2.13 Forest (F) District

A. Purpose: To conserve public lands used for drinking water protection, forestry and public recreational activities.

B. Permitted Uses: The following land uses require a zoning permit issued by the Zoning Administrator (see Section 7.2):

1. Agricultural and Forestry Uses (See Sec. 4.3 Exemptions)
2. Family Child Care Home
3. Group Home
4. Private Broadcast Facility

C. Conditional Uses: The following land uses require conditional use review by the Development Review Board (see Section 4.8) and a zoning permit issued by the Zoning Administrator (see Section 7.2):

1. Building and Construction Trades
2. Commercial Broadcast Facility
3. Earth Extraction Operations
4. Earth Processing Operations
5. Recreation
6. Wood Processing

CHESTER UNIFIED DEVELOPMENT BYLAWS

- a) It does not reduce the number of parking spaces below the number needed to accommodate the principal use(s) intended to be served by the parking area.
 - b) It does not interfere with pedestrian or vehicular access or circulation.
3. The food truck, food cart, or food stand must not have any signs permanently mounted on the site and the provisions of Section 3.26 will not apply. The use may be advertised with one or more signs mounted on the truck, cart or stand, not to exceed a total sign area of 24 square feet. Painted or vinyl graphics on the food truck, food cart or food stand are not considered a sign. Up to two sandwich board signs not to exceed 2 feet by 4 feet in size may be located within 100 feet of the truck, cart or stand. If a free-standing sign support structure already exists on the property it may be utilized.
 4. The operator must provide appropriate receptacles for trash, recyclables, and food waste within 10 feet of the food truck, food cart, or food stand, and receptacles must be secured or emptied daily.
 5. The operator must conform to applicable state health and safety codes.
 6. The operator must conform to the Performance Standards of Section 4.9.
 7. The Development Review Board may set a permit expiration date after which the applicant must reapply to the DRB for a new permit and may as a condition require annual review and renewal of the permit by the Zoning Administrator.

3.32 Tiny Houses

- A. Tiny houses permanently affixed to a foundation and connected to utilities (i.e., water, sewage and electricity) shall be subject to the same requirements as a permanent structure (i.e., single-household dwelling or accessory dwelling unit).
- B. Tiny houses on wheels that are occupied and connected to utilities (i.e., water, sewage and electricity) for more than a total of 180 days in any calendar year shall be subject to the same requirements as a permanent structure (i.e., single-household dwelling or accessory dwelling unit).
- C. All other tiny houses on wheels shall be considered a recreational vehicle/travel trailer.

3.33 Cottage Courts

- A. The purpose of this provision is to allow for greater flexibility to encourage the production of more affordable forms of housing in Chester, in accordance with 24 V.S.A. §4417.
- B. A Cottage court is subject to Conditional Use review by the Development Review Board and issuance of a Zoning Permit. In addition to the Conditional Use standards in Section 4.8, cottage courts are also subject to the following standards.
 1. The minimum lot area shall be 1 acre, if served by municipal water and sewer, or 2 acres, if served by an on-site well and/or septic.
 2. The maximum density shall be 10 dwellings per lot.

CHESTER UNIFIED DEVELOPMENT BYLAWS

3. The maximum height of each structure shall be 22 feet.
4. The total habitable floor area for each cottage shall not exceed 900 square feet.
5. Dwellings shall be separated from each other by at least 20 feet and no more than 40 feet. Dwellings shall face the common space and be set back from the common road edge at least 20 feet but no more than 30 feet.
6. Accessory structures shall meet the minimum setback distance from lot lines per the zoning district in which it is located.
7. A minimum area of 20% of the lot shall be maintained as common open space.
8. All dwelling units shall abut and face the central open space. The common open space shall have cottages abutting at least two sides.
9. One parking space per dwelling unit is required.
10. The development shall be served by a single access onto a public highway, and shall have an internal road sufficient to access all off-street parking.
11. Applicant is required to submit, along with the permit application, a potable water supply and wastewater permit for the design of the necessary system or a letter from the sewer/water provider that sufficient capacity is available for the site.
12. Lots developed under this provision are prohibited from being subdivided.
13. The lot for the cottage court shall be held in common ownership. Applications shall include legal documentation that, to the DRB's discretion, adequately articulates how common lands and utilities shall be maintained.

CHESTER UNIFIED DEVELOPMENT BYLAWS

COMMUNITY WATER SYSTEM: any surface water or groundwater supply system used as a source of drinking water for a public water system as defined under 10 V.S.A. §1671(5).

CONSTRUCTION DRAWINGS: The drawing showing the location, profile grades, size and types of sewers, water mains, roads or other capital improvements, rights of way, easements, and property lines.

COTTAGE COURT: A group of three to ten detached one to three-bedroom dwellings on a single lot, arranged on at least two sides of a central court which is visible from the street. Examples of this include cottage courts, bungalow courts, and horizontal apartments. Such units shall not be used for short-term rentals. Tiny houses, whether on wheels or on foundations, that are connected to utilities and occupied for 180 or more days in a calendar year may be approved as a cottage court. Units may be owned or rented. Cottage court developments are not mobile home parks.

DEVELOPMENT: The division of a parcel into two or more parcels, the construction, reconstruction, conversion, structural alteration, relocation or enlargement of any building or other structure, or of any mining, excavation or landfill, and any change in the use of any building or other structure, or land, or extensions of use of land [the Act §4303 (10)]. For the purposes of the Flood Damage Prevention provisions, *development* means any man-made change to improved or unimproved real estate, including but not limited to buildings or other structures, mining, dredging, filling, grading, paving, excavation or drilling operations or storage of equipment or materials.

DE MINIMIS IMPACT: Small or minimal impacts. For the purposes of telecommunication facilities, de minimis impact includes collocation of an array on an existing permitted tower, upgrades to existing permitted equipment and similar projects; but it does not include access road expansions, higher fences, new towers, extending the height of existing towers and similar projects.

DEVELOPMENT ENVELOPE: A specific area delineated on a lot within which all structures are to be located, and outside of which no structures are to be located.

DRIVEWAY: A minor, private travel way serving no more than one (1) parcel, which provides vehicular access from an adjoining road to a parking space, garage or other structure. See also Road.

DWELLING, MULTIPLE FAMILY: See **DWELLING, MULTIPLE-HOUSEHOLD**

DWELLING, MULTIPLE-HOUSEHOLD (or MULTI-HOUSEHOLD): Building used as living quarters by three or more households living independently of each other. For the purposes of these Bylaws, multi-household dwellings have two categories:

CHESTER UNIFIED DEVELOPMENT BYLAWS

- MULTI-HOUSEHOLD DWELLING (3-4 UNITS) is one building that contains no more than four units for households to live independently; and,
- MULTI-HOUSEHOLD DWELLING (5+ UNITS) is one building that contains five or more units for households to live independently.

DWELLING, SINGLE-FAMILY: See **DWELLING, SINGLE-HOUSEHOLD**

DWELLING, SINGLE-HOUSEHOLD: A building or part thereof used as living quarters for one household and containing independent cooking, sanitary and sleeping facilities. It shall include prefabrication and modular units, but shall not include motel, hotel, boarding house, or tourist home.

DWELLING, TWO-FAMILY DWELLING: See **DWELLING, TWO-HOUSEHOLD**.

DWELLING, TWO-HOUSEHOLD: A building on a single lot containing two dwelling units, each of which is totally separated from the other by an unpierced wall extending from ground to roof or an unpierced ceiling and floor extending from exterior wall to exterior wall, except for a common stairwell exterior to both dwelling units.

DWELLING UNIT: A space consisting of one or more rooms designed, occupied or intended for occupancy as a separate living quarters, with cooking, sleeping, and sanitary facilities provided within that space for the exclusive use of one or more persons maintaining a household. See also Accessory Dwelling Unit, Single-Household Dwelling, Two-Household Dwelling and Multiple-Household Dwelling.

EARTH EXTRACTION OPERATIONS: A use involving the on-site removal of surface and subsurface materials, including soil, sand, gravel, ~~stone, rock~~ or organic substances other than vegetation, from land or water. Customary extraction operations include sand and gravel pits, ~~rock quarries~~, and accessory operations such as the crushing, screening, and temporary storage of materials excavated on-site.

EARTH PROCESSING OPERATIONS: A use involving the manufacturing of dimensional material at a stone quarry, including hammering, drilling the stone off a quarry face, and processing it into finished goods, and temporary storage of those goods on-site.

EASEMENT: The grant of one or more of the property rights by the property owner to and/or for use by the public, a corporation or another person or entity. This may include conservation, drainage, utility, scenic or viewshed easements.

EXTERNALLY LIT SIGN: A sign with a light source that originates from outside the materials of the sign.

CHESTER UNIFIED DEVELOPMENT BYLAWS

(a) Any project for improvement of a structure to correct existing violations of state or local health, sanitary, or safety code specification which have been identified by the local code enforcement official and which are the minimum necessary to assure safe living conditions; or

(b) Any alteration of a “historic structure” provided that the alteration will not

preclude the structure’s continued designation as a “historic structure”.

For the purposes of determining “substantial improvement” value and exceptions in (a) only and no other purpose, the Zoning Administrator is “the local code enforcement official.”

SUBSTANTIALLY COMPLETED: A building, structure or infrastructure that is sufficiently constructed so that it can be used for its intended purpose with no further construction.

TAVERN: See Bar.

TINY HOUSE: A fully-equipped, free-standing, single-household dwelling averaging up to 400 square feet in size, excluding sleeping lofts. They come in two forms; those on wheels and those on a foundation.

TINY HOUSE COMMUNITY: A group of three or more tiny houses on plots within a tract of commonly-owned land with shared facilities, typically including traffic access and circulation facilities, electricity, water and wastewater infrastructure, and other facilities.

TOURIST LODGING: Overnight accommodations provided to transients for compensation, including bed & breakfasts, boardinghouses, inns, hotels and other overnight accommodations.

TOWN CONSULTANT ENGINEER: Licensed person duly designated by the Town Manager to perform this function.

TOWN HIGHWAY, CLASS 1: Highways designated by the Highway Board which are part of a state highway route and which carry a state highway route number.

TOWN HIGHWAY, CLASS 2: Highways designated by the Legislative Body of the municipality with the approval of the Highway Board for securing trunk lines of improved highways from town to town and to places which by their nature have more than normal amounts of traffic.

TOWN HIGHWAY, CLASS 3: All other travelled town highways, other than Class 1 or Class 2, designated by the Legislative Body of the municipality, after conference with a representative of the Highway Board.

TOWN HIGHWAY, CLASS 4: All other town highways, including trails and pent roads, other than Class 1, 2, or 3 highways, designated by the Legislative Body of the municipality .

Chester Unified Development Bylaws - Proposed Allowed Uses by District

03.12.2024

Allowed Uses	VC	VG	VMU	GB	SV	N	RES-2	A3	OS	RMU	RUR-5	RUR-8	CON
Accessory Dwelling Unit	P	P	P	P	P	P	P	P		P	P	P	
Accessory Structure	P	P	P	P	P	P	P	P	CU	P	P	P	
Accessory Use	P	P	P	P	P	P	P	P		P	P	P	
Agriculture/Forestry*			P	P		P	P	P		P	P	P	P
Animal Hospital			CU	CU			EU	EU		CU	CU		
Animal Kennel				CU			EU	EU		CU	CU	CU	
Art Studio and/or Gallery	CU	P	P	P	CU		CU			CU	CU	CU	
Arts & Entertainment	CU	CU	CU	CU	CU			EU	CU	CU			
Automotive Sales/Service			CU	CU						CU			
Automotive Fuel			CU	CU						CU			
Building & Construction Trades	CU		CU	CU			EU	EU		EU	CU	CU	CU
Campground							CU	EU		EU	CU	CU	
Civic/Institutional	CU	CU	CU	CU	CU	CU	CU	EU	CU	CU	CU	CU	
Club	CU	CU	CU	CU									
Commercial Broadcast Facilities	CU		CU	CU		CU		EU		EU		CU	CU
Commercial Storage Units				CU			EU	EU		CU			
Dwelling - Multi-Household (3-4 units)	P	P	P	CU	P	P	CU	EU		CU	CU		
Dwelling - Multi-Household (5+ units)	CU	CU	CU	CU	CU	CU	CU	EU		CU	CU		
Dwelling - Single Household	P	P	P	CU	P	P	P	P		P	P	P	
Dwelling - Two Household	P	P	P	CU	P	P	P	P		P	P	P	
Earth Extraction Operations							CU				CU	CU	CU
Earth Processing Operations											CU	CU	CU
Family Childcare Facility	CU	CU	CU	CU	CU	CU	CU	EU		CU	CU	CU	
Family Childcare Home	P	P	P	P	P	P	P	P		P	P	P	P
Food Truck/Food Cart/Food Stand	CU	CU	CU	CU	CU	CU	CU	EU	CU	CU	CU		
Group Home	P		P	P	P	P	P	P		P	P	P	P
Health Care Facility	CU	CU	CU	CU				EU		CU			
Heavy Construction Trades*							EU	EU			EU	EU	
Home Business	CU	CU	CU	CU	CU	CU	CU	EU		CU	CU	CU	
Home Occupation	P	P	P	P	P	P	P	P		P	P	P	
Industrial Facility				CU									
Light Industry	CU	CU	CU	CU				EU		CU			
Mobile Home Park							CU			CU	CU		
Multi-Purpose	CU	P	CU		CU	CU				CU			
Nursery			CU	CU			EU	EU	CU	CU	CU	CU	
Open Market	CU	CU	CU	CU					CU	CU			
Personal Service Shop	CU	CU	CU	CU						CU			
Private Broadcast Facility	P		P	P	P	P		P		P		P	P
Processing Construction & Landscaping Aggregate							EU						
Professional Office	CU	P	CU	CU	CU	CU	CU	EU		CU	CU		
Pub/Tavern/Bar	CU	CU	CU	CU						CU			
Recreation	CU	CU	CU	CU	CU	CU	CU		CU	CU	CU	CU	CU
Residential Care Home	CU	CU	CU	CU						CU			
Restaurant	CU	P	CU	CU	CU	CU		EU		CU			
Retail Store	CU	P	CU	CU	CU	CU		EU		CU			
Sawmill									CU		CU	CU	
Tiny House Community							CU						
Tourist Lodging	CU	CU	CU		CU	CU	CU	EU		CU	CU		
Wireless Communication Facility							CU				CU		
Wood Processing				CU			EU	EU	CU	CU	CU	CU	CU

NOTES:

P = permitted use, CU = conditional use review

A blank box indicates that a land use is not allowed in that district.

This table is intended as a reference only. If there are any differences, the text of the Unified Development Bylaws are the official zoning requirements for the Town of Chester.

ZONING DISTRICTS:

Village Center (VC)

Village Green (VG)

Village Mixed Use (VMU)

(Formerly Residential-Commercial)

General Business (GB)

(Formerly Commercial-Industrial)

Stone Village (SV)

Neighborhood (N)

(Formerly R-20 and portions of R-40)

Open Space (OS)

Residential 2-Acre (RES-2)

(Formerly portions of R-40)

Rural Mixed Use (RMU)

(Formerly Residential-Commercial and Adaptive 3)

Rural 5-Acre (RUR-5)

(Formerly R-120/R-3)

Rural 8-Acre (RUR-8)

(Formerly Conservation-Residential)

Conservation (CON)

(Formerly Forest)

Chester Unified Development Bylaws - Proposed Dimensional Standards by District

Dimensional Standards	VC	VG	MU	GB	SV		N		OS	RES-2	RMU	RUR-5	RUR-8	CON
			W&S		W&S	On-Site	W&S	On-Site						
Minimum Lot Size (acres)	1/8		1/5		1/5		1/5		5	2	2			
Minimum Lot Size (square feet)	5,445	3,600	8,712	20,000	8,712	30,000	8,712	30,000	217,800	87,120	87,120			
Density Standard (Building Unit/Acre)												1 unit / 5 Acres	1 unit / 8 Acres	
Minimum Lot Frontage (feet)	50	30	75	100	80	120	60	150	200	150	150	150	200	
Minimum Front Yard Setback (feet)	10	0	15	20	20	40	15	25	50	40	40	40	40	
Minimum Side Yard Setback (feet)	5	0	15, 30	15, 30	20	30	10	20	50	30	30	30	30	
Minimum Rear Yard Setback (feet)	10	8	15, 30	15, 30	16	30	10	20	50	30	30	30	30	
Maximum Lot Coverage (%)	80%	90%	70%	70%	50%	30%	50%	30%	10%	20%	30%	20%	10%	
Maximum Building Height (feet)	35	35	35	35	35	35	35	35	35	35	35	35	35	

NOTES:

This table is intended as a reference only. If there are any differences, the text of the Unified Development Bylaws are the official zoning requirements for the Town of Chester.

ZONING DISTRICTS:

Village Center (VC)

Village Green (VG)

Mixed Use (MU)

(Formerly Residential-Commercial and Adaptive 3)

General Business (GB)

(Formerly Commercial-Industrial)

Stone Village (SV)

Neighborhood (N)

(Formerly R-20 and portions of R-40)

Open Space (OS)

Residential 2-Acre (RES-2)

(Formerly portions of R-40)

Rural 5-Acre (RUR-5)

(Formerly R-120/R-3)

Rural 8-Acre (RUR-8)

(Formerly Conservation-Residential)

Conservation (CON)

(Formerly Forest)